

# 8

## Drawing and Editing Objects

8.1	Drawing Frames . . . . .	92
8.2	Drawing Lines . . . . .	93
8.3	Text Overflow and Linking Frames . . . . .	94
8.4	Drawing Aids . . . . .	97
8.5	Selecting Objects . . . . .	99
8.6	Moving Objects . . . . .	100
8.7	Resizing Objects . . . . .	101
8.8	Rotating Objects . . . . .	102
8.9	Editing Objects using the Edit Menu . . . . .	103
8.10	Embedding Objects . . . . .	104
8.11	Path Edit Mode . . . . .	106

This chapter describes the tools for drawing and editing *objects*. You can draw objects anywhere on the page, even overlapping other objects, but not across page boundaries. There are three types of objects: *frames*, *lines* and *ruler guidelines*.

Frames are the basic building blocks in **Ovation Pro**. They are used to hold the text and pictures that appear on the page and are normally rectangular (but may be any closed shape).

Lines are normally straight or curved open paths, but may be any shape (open or closed). Even if line paths are closed, they cannot contain text or graphics. Typically, Lines are used to add additional graphics to the page and for this purpose are better than frames because they use less memory.

Ruler guidelines are used to help align objects on the page.

### 8.1 Drawing frames

Frames in *Ovation Pro* may be rectangular, elliptical or irregular. In the latter case they may be constructed from straight and curved line segments. To draw a frame, left click on the Frame tool and on the required shape from the toolbox (fig 8.1).

Normally after drawing a frame or line, the Select tool is automatically re-selected ready for text entry. If you wish to draw a number of frames in succession, choose the Frame tool by right clicking, whereupon it will remain selected until another tool is chosen.

An empty frame can contain either text or a picture. If you wish to put a picture in a text frame, you must delete all the text first. Similarly, if you want to put text in picture frame, you must delete the picture first. To delete a picture select it first by double clicking on it and then delete it using the menu

**Menu → Edit → Delete picture      Ctrl+K**

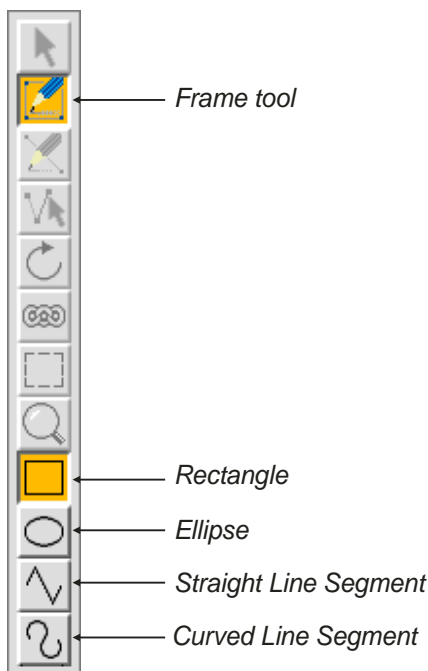

Fig. 8.1 - The toolbox.

### Rectangular Frames

Move the crosshair to where you want one corner of the rectangle to be, then left click and drag to the opposite corner. Finally release the button complete the operation (fig. 8.2).

To draw a perfect square, hold down Shift while drawing the rectangle (or use grid lock):

**Menu → View → Grid      Ctrl+Shift+G**

### Elliptical or Circular Frames

Ellipses are arranged to fit within a rectangular area. Move the crosshair pointer to the centre of the area then left click and drag to the required size. Finally release the button to complete the operation (fig. 8.3).

To draw a perfect circle, hold down Shift while drawing the ellipse (or use grid lock).

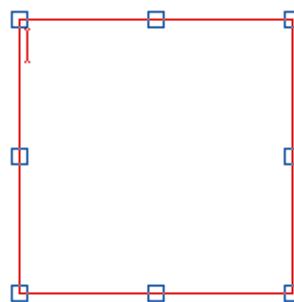

Fig. 8.2 - A rectangular frame.

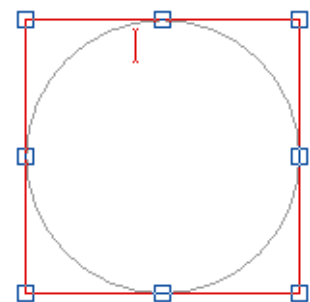

Fig. 8.3 - An elliptical frame.

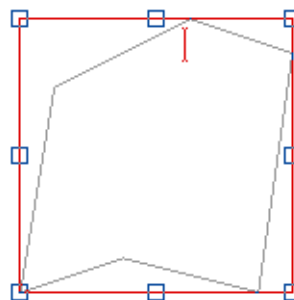

Fig. 8.4 - A straight-sided irregular frame.

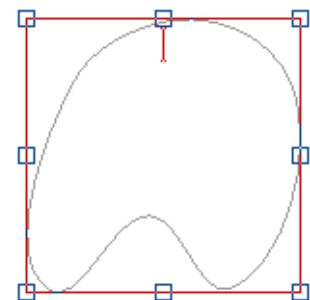

Fig. 8.5 - A curved-sided irregular frame.

## Irregular Frames

Choose Straight Line Segment or Curved Line Segment from the toolbox. Left click where you want the line to start, then move to the endpoint and left click again. You can keep adding line segments to the path by moving to the endpoint of each new line and left clicking. Alternatively click and drag to each new endpoint, to allow auto-scrolling at the edge of the window. You cannot go beyond the page boundaries.

At any time you can change between straight and curved lines by choosing the required type from the toolbox. To draw perfectly horizontal or vertical lines, hold down Shift to constrain pointer movement to the horizontal or vertical.

Left double-click or right click to finish the path. When drawing frames, the path is closed automatically (figs. 8.4 & 8.5).

The shape of irregular frames can be edited in Path Edit Mode (see 8.11).

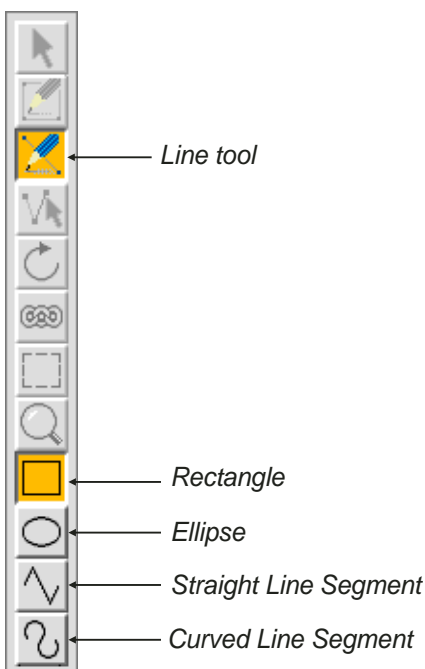

Fig. 8.6 - The toolbox.

## 8.2 Drawing lines

The Line tool in allows you to draw rectangles, ellipses, straight lines (fig. 8.7) and curved lines (fig. 8.8). You can draw single lines or sequences of connected lines. By default lines sequences are open path, but can be closed (fig. 8.9 & 8.10) using an option in Path Edit Mode (see 8.11).

To draw a line, choose both the Line tool and the required shape from the toolbox (fig. 8.6). The method of drawing lines is identical to that described on the previous page for frames.

Remember that objects drawn with the line tool cannot contain text or pictures.

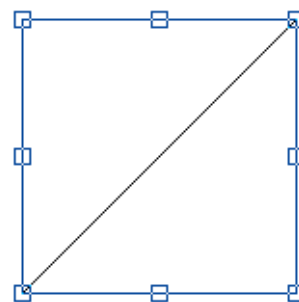

Fig. 8.7 - A straight line.

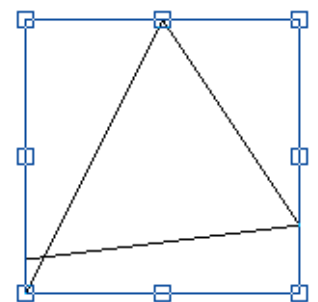

Fig. 8.9 - An open path line.

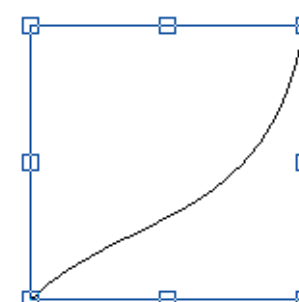

Fig. 8.8 - A curved line.

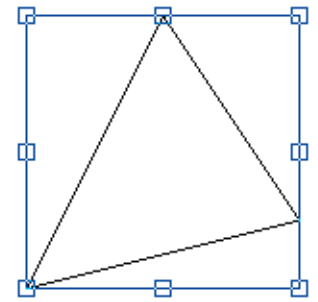

Fig. 8.10 - A closed path line.

### 8.3 Text Overflow and Linking Frames

Once you have drawn a frame, you may type or import text into it (see 3.1 & 3.3). If you type past the bottom of the frame or import a story that is too big, the *overflow flag* will be displayed in the bottom right corner of the frame (fig. 8.12). In this situation, the overflowed text will not be visible and cannot be edited.

There are a number of things you can do to remove the overflow flag:

1. Delete some of the text to make space for the overflowed text.
2. Make the frame big enough to display all of the text.
3. Link the overflowed frame to another empty frame, so that the text will automatically flow into the second frame.

### Linking Frames

To link two frames, select the Link tool from the toolbox (fig. 8.11a). Now click in the first frame and drag the pointer to the second frame. During this operation, the pointer will change to a link symbol. After linking, the overflow flag will disappear from the first frame, but may be displayed in the second frame if there is still not enough space for the entire text story (fig. 8.13). If you wish you can then link the second frame to a third frame. You can link any number of frames together in this way, even if they are on different pages.

### Editing Text in Linked Frames

Once frames are linked, text will flow automatically between them, and may be edited as normal. Caret movement will work correctly between the frames, and you may select text across them by clicking or dragging in the usual way.

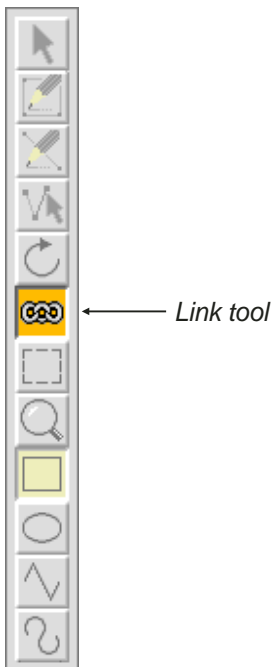

Fig. 8.11a - The toolbox.

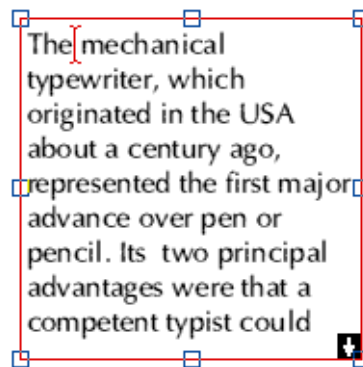

Fig. 8.12 - Frame with overflow flag.

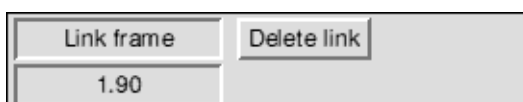

Fig. 8.11b - The info palette having selected the Link Tool

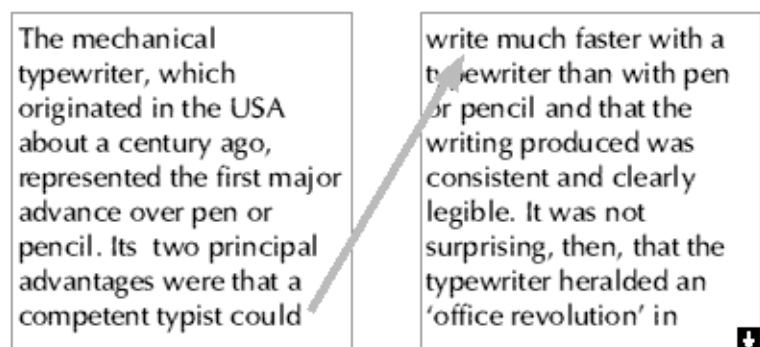

Fig. 8.13 - Two linked frames with link shown.

### Linking Frames on Master pages.

Frames on the Master pages can be linked. As well as the usual type of linking there is another kind called 'auto-linking'. This means that when the text in a master frame overflows in the document, it will flow into the same frame on the next page i.e. a page will be automatically created with new frames linked to those on the preceding page.

Often this feature is used with a chain of linked frames, where the last frame in the chain is auto-linked to the first frame in the chain. When the last frame overflows, a new page is inserted and the text flows into the first frame on the new page.

To create an auto-link, use the Link tool in the usual way, but drag back onto the first frame in the linked chain (*fig. 8.14*). In the case of a single frame, drag back onto that frame (*fig. 8.15*).

An 'auto-link' is shown in green when the Link tool is selected.

It is possible to have more than one auto-link chain in a chapter.

To delete an auto-link, choose the Link tool, click over the link so that it is selected i.e. shown in red. Now press Delete or click the 'Delete link' button on the info palette.

A typical use of auto-linking is a template document for labels. The idea is to draw the labels on the master pages so that as each page is filled,

a new page of labels is inserted. Each label on the master page is linked to the next label, and the last label on the master page is linked to the first.

To create this type of document, open the master pages and draw the labels as required. Now use the Link tool to link all of the labels in the order that you wish text to flow through them. Link the last label back to the first label. This link will be shown in green, indicating that it is an auto-link and will generate a new page when it overflows. Close the master pages, and save the document as a template.

You can now type in the labels. Note that since we are using linked frames, you can use Ctrl Return to start a new label.

If you wish to import data e.g. names and address from a file, the data needs to be formatted correctly first. Each field should be separated by a Line Feed (0x0A) or Carriage Return (0x0D) or both and each record by a Form Feed (0x0C). If your data is in CSV format, then you will need to convert your file before it is imported.

```
Name<0A>
Address 1<0A>
Address 2<0A>
Postcode<0C>
Name<0A>
Address 1<0A>
```

It is also possible to use mail merge to solve this problem (*see 12.5*).

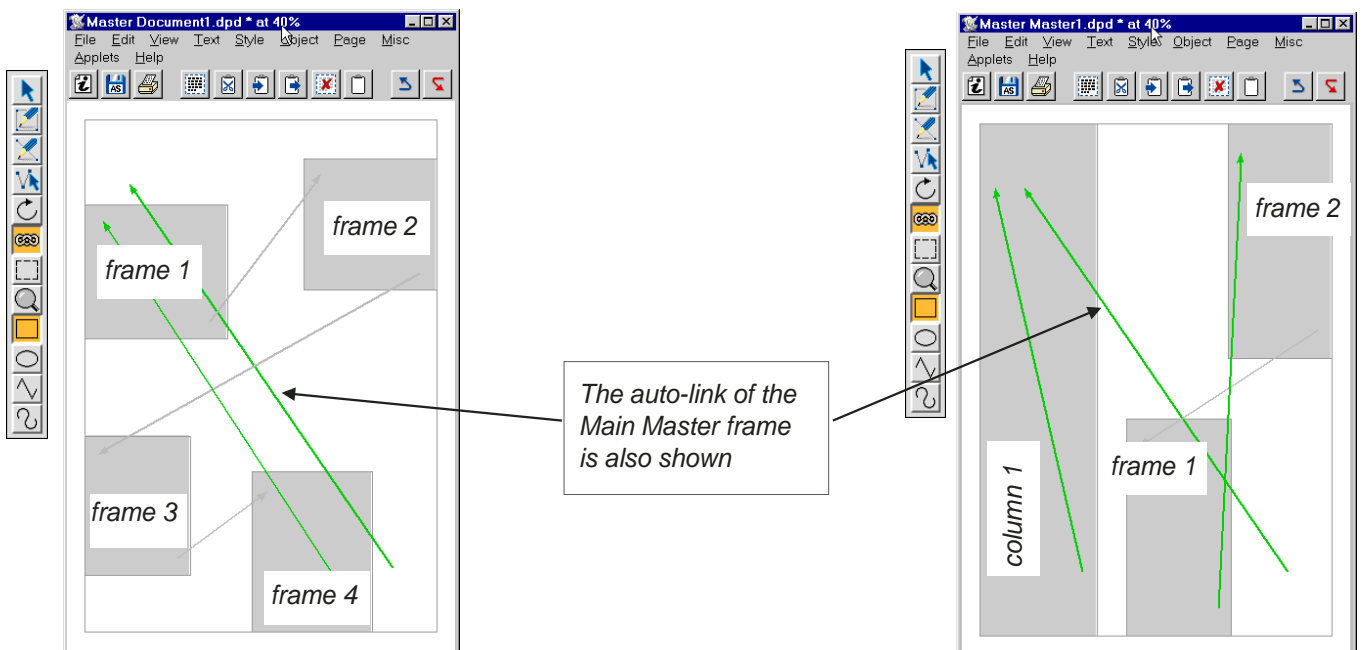

Fig.8.14 - Autolink: text flows from frame 1 to 2, then to 3 and to 4 and finally to frame 1 on following page.

Fig.8.15 - Auto-linking column 1 results in overflowing text appearing on next page in column 1. Frame 1 overflows to frame 2, then to frame 1 on following page.

## Show Flow

When you choose the Link tool, arrows are drawn in the document indicating where text flows (*fig. 8.13*).

## Changing a Link

If you link from a frame that already has an outward link, the original link is removed and text flows according to the new link.

## Unlinking Frames

To unlink frames, choose the Link tool so that you can see the arrows that show text flow. To remove a link, left click on the appropriate arrow, so that it is highlighted i.e. shown in black (*fig. 8.16*). Now press Delete to remove the link. Or click on the Delete box on the info palette (*fig. 8.11b*).

An auto-link will be shown in red when selected.

In the case of a chain of linked frames with an auto-link the auto-link must be removed before you can remove or change the other links.

Removing a link has the effect of removing the text from the linked frame (and any subsequently linked frames) and joining it back to the end of the previous frame. This will cause the previous frame to overflow, but no text will be lost.

## Frame Break

You can force the caret to the start of the next linked frame by pressing Ctrl Return, or by choosing

**Menu** ⇨ **Misc** ⇨ **Insert** ⇨ **New page**.

The break character may also be deleted, causing text that follows to flow back into the previous frame.

## Special Notes

The following points should be considered when linking frames:

1. You cannot link to or from the Main frame, since this is already linked.
2. You cannot link picture frames.
3. If a frame contains text, it can only be linked to an empty frame that doesn't already have an inward link or to the first frame of a chain of linked frames as long as these linked frames are empty.
4. If a frame is empty, it can be linked to any text frame that doesn't already have an outward link or to the first frame of the chain of linked frames.
5. You cannot delete linked frames. But a page with linked frames can be deleted if all linked frames are within that page only.
6. You cannot cut or copy linked frames to the clipboard, or copy linked frames using drag and drop.

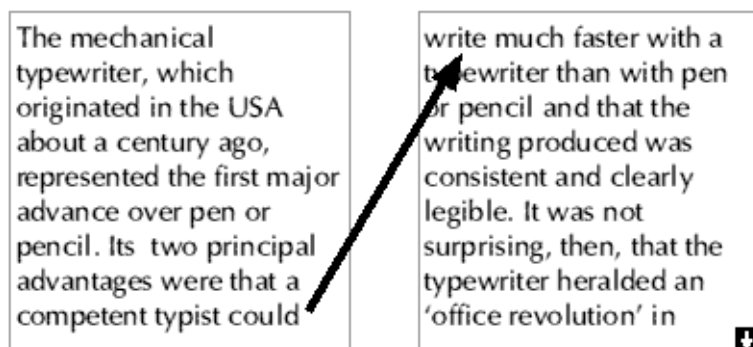

*Fig. 8.16 - Two linked frames with highlighted arrow.*

## 8.4 Drawing Aids

There are a number of facilities available to help you draw and manipulate objects.

### Cancelling an Operation

Most operations concerned with manipulating objects can be cancelled by pressing Esc at any time. So if you are in the middle of drawing a frame, pressing Esc will cancel the operation.

### Auto Scrolling

The document window will automatically scroll if you drag close to its edges. The speed of scrolling is determined by how close the pointer is to the window edge; the closer it is, the faster it scrolls.

### Nudging the Pointer

When drawing, moving and resizing objects you may position the pointer more accurately by pressing the cursor keys to 'nudge' it one pixel in the required direction. In this case Object snap (see next paragraph) is overruled.

### Object Snap

When drawing, moving or resizing objects, the edges of the objects snap into alignment with the edges of other objects on the same page. Top edges snap to top edges, bottom edges to bottom edges etc (*fig. 8.19*).

Object snap may be disabled on **Preferences** (*see 15.13*), and is automatically disabled if grid lock is enabled.

### Grid

If object grid lock is enabled (*see 7.4*), and an object is drawn or resized, its edges will snap to the grid. If an object is moved, it will jump in steps of the grid spacing.

If grid lock is enabled, the **Menu⇨Object⇨Snap to grid** option will snap the top left corner of the selected object to the nearest grid point. The size of the object is not altered.

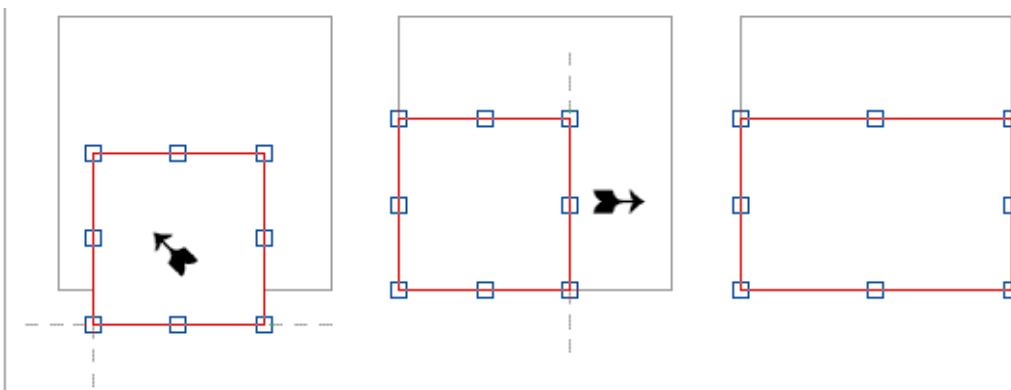

*Fig. 8.17 - The selected frame is dragged in the direction of the arrow so that the left and bottom edges snap to the larger frame. The right edge of the selected frame is then dragged to the right until it snaps to the right edge of the larger frame.*

## Ruler Guidelines

**Menu**⇨**View**⇨**Options**⇨**Rulers**   **Ctrl+R**

When rulers are enabled (*see 7.3*), you can draw your own vertical or horizontal guidelines across the page. Edges of object will snap to these guidelines when dragged close to them.

To draw a vertical guideline, left click on the horizontal ruler at the required position. Alternatively, left click then drag the guideline to the required position. To draw a horizontal guideline, do the same, but on the vertical ruler.

To move a guideline, move the pointer over the guideline, so that the pointer changes to the guideline tool (*fig. 8.18*). Now drag the guideline to the required position. You can also drag a number of selected guidelines in a single operation.

To select guidelines, left click over the first one, then Ctrl left click over other guidelines to add them to the selection. Selected guidelines are shown in red.

To move a selected guideline to an exact position, choose **Menu**⇨**Object**⇨**Modify** and enter a value in the dialogue box displayed (*fig. 8.19*).

To delete a guideline drag it to the extreme edge of the page. Alternatively, to delete selected guidelines choose **Edit**⇨**Delete**.

To delete all vertical guidelines, Ctrl left click on the horizontal ruler. To delete all horizontal guidelines Ctrl left click on the vertical ruler.

Guidelines are normally drawn over the top of all frames, but an option on

**Menu**⇨**Misc**⇨**Preferences**   **Ctrl+Shift+P**

allows them to be drawn behind instead (*see 15.13*). Snap to ruler guidelines may be disabled on **Misc**⇨**Preferences** (*see 15.13*), and is automatically disabled if grid lock is enabled.

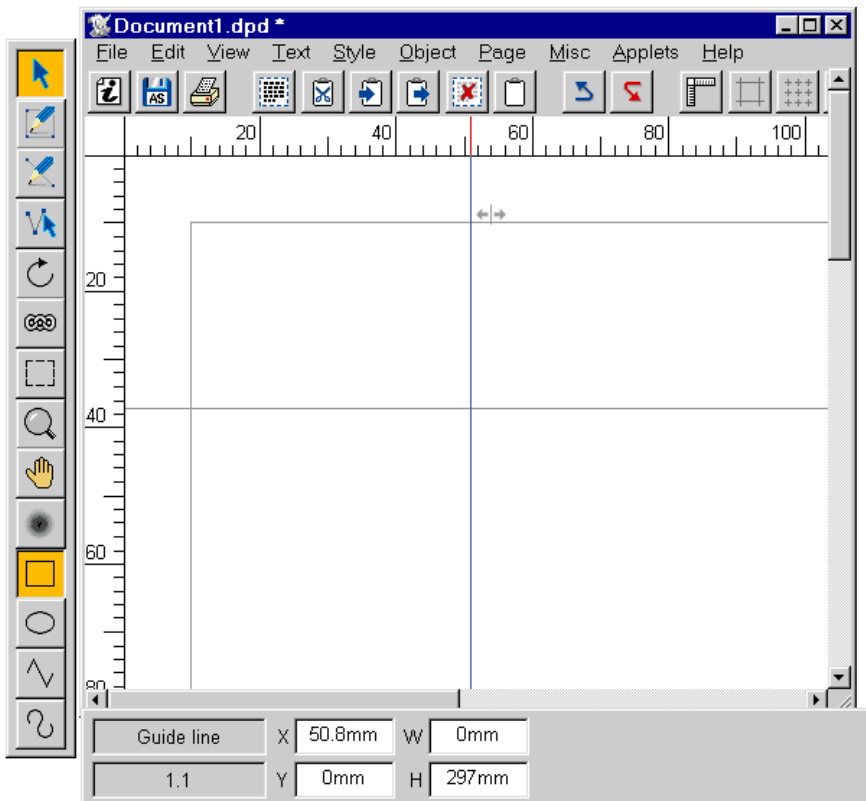

Fig. 8.18 - Document with vertical and horizontal ruler guidelines.

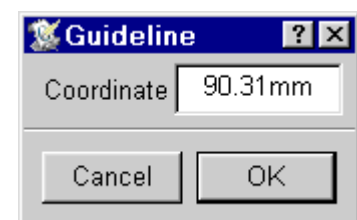

Fig. 8.19 - Modify guideline.



## 8.5 Selecting objects

Before you can make changes to an object you must select it. Ensure that the Select tool is active (fig. 8.20) then left click over the object. This selects the object and deselects any other objects.

When an object is selected, it is enclosed in a red 'bounding box' with 8 blue 'handles' located around its edges. The bounding box is a rectangular guideline that completely encloses the object (fig. 8.21 & 8.22). A handle is a small square which can be dragged to resize the object.

In addition to frames and lines, you may also select ruler guidelines. When selected they are shown in red, but do not have handles.

You can select more than one object by holding down Control and left clicking each additional object. Control left clicking on an object that is already selected causes it to be deselected.

Another way of selecting all the objects in an area is to construct a select box around the area by holding down Ctrl Shift and pressing the left mouse button at one corner of the area to be selected and dragging the box to the opposite corner. Release the button when all the objects to be selected are wholly within the select box; the objects will then be selected.

If the object you want to select is obscured by another object, hold down Ctrl Shift and double-click over the top object to select the object beneath. You may keep doing this to select progressively deeper objects until you eventually return to the top object.

If you want to permanently group a number of objects, use **Object**→**Group** or **Ctrl+Shift+K** (see 9.11).



Fig. 8.20 - The **Select tool**.

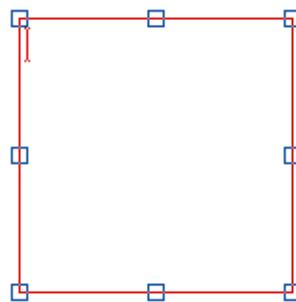

Fig. 8.21 - An active rectangular frame with eight handles for resizing.

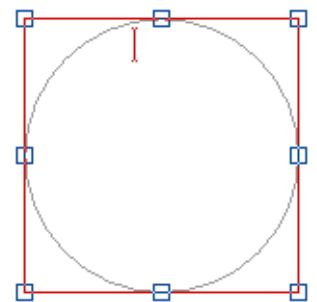

Fig. 8.22 - An active elliptical frame with eight handles for resizing.

## 8.6 Moving Objects

To move an object, first ensure the Select tool is selected. Then left click over the object and keep it pressed and completely still until the Move pointer appears (*fig. 8.23*). Now drag the object to its destination (which may be anywhere on the same page) and release the button. If you hold down Ctrl, you may drag the object immediately with the right button, without holding the button down until the Move pointer appears.

If you have a number of objects selected, moving one of them will move the entire selection. You can move a mixed selection of frames, lines and ruler guidelines if you wish.

To constrain movement to the vertical or horizontal, hold down Shift while dragging.

You can position objects precisely using the info palette or the **Modify** dialogue box (*see 9.1*).

### Using the Info Palette

**X** and **Y** on the info palette (*fig 8.24*) are the coordinates of the top left corner of the selected object or group. Coordinates are measured from the top left corner of the page. **X** and **Y** may be modified to change the position of the object. Press Return after modifying the values to update the document.

If there is a selection of objects, **X** and **Y** refer to the first object selected. In this case if **X** and **Y** are modified, the first object is moved to the position specified and the rest are moved proportionally.

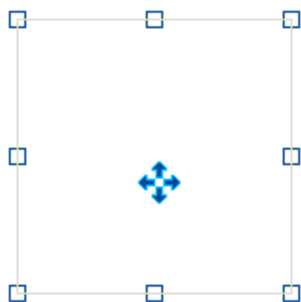

Fig. 8.23 - The Move tool moves

## Drag and Drop

You can move or copy objects using the drag and drop facility. Unlike the normal move operation described above, you can drag and drop objects to any page in the same document or in a different document.

To drag and drop selected objects, hold down Alt then drag them to the required position.

If you drag and drop within the same document, objects are *moved*; if you drag and drop to another document, objects are *copied*.

If you hold down Shift Alt while dragging, the above operations are transposed. So, if you drag and drop within the same document, objects are *copied*; if you drag and drop to another document, objects are *moved*.

If you start a drag operation and wish to cancel it, press Esc.

Please note that you cannot drag and drop master objects or linked frames. But you can move linked frames within a chapter.

For drag and drop of selected text *see 3.8*.

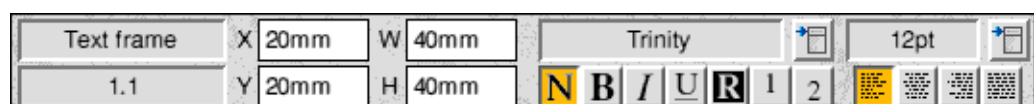

Fig. 8.24 - The info palette gives the position of the selected object. You can reposition it by changing the **X** and **Y** values.

## 8.7 Resizing Objects

To change the shape or size of an object move the pointer over one of the 8 handles so that the Resize pointer appears (fig. 8.25). Now press the left mouse button and drag the mouse until the object is the size and shape that you want. There are two types of handles:

- Corner handles will resize the object both horizontally and vertically.
- Centre handles will make the object either wider or longer.

If you hold down Ctrl while dragging, the original shape (aspect ratio) of the object will be maintained. If you hold down Shift, the object bounding box shape will be constrained to a square.

If you have a number of objects selected, resizing one of them will resize the rest proportionally.

You can resize objects precisely using the info palette or the **Object**→**Modify** dialogue box or **F7** (see 9.2). The sizes **W** and **H** mentioned on the info palette refer to the first object selected.

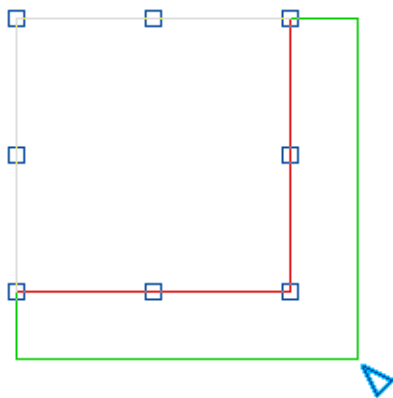

Fig. 8.25 - Move the pointer over a handle and drag the resize tool to resize the object.

### Using the Info Palette

**W** and **H** on the info palette (fig. 8.26) are the width and height of the selected object or group. **W** and **H** can be modified to change the size of the object. Press Return after modifying the values to update the document.

If there is a selection of objects, **W** and **H** refer to the first object selected. In this case if **W** and **H** are modified, the first object is resized as specified and the rest are resized proportionally.

**X** and **Y** on the info palette refer to the distance from the top left corner of the page to the top left corner of the object frame. By changing these values you can reposition the object frame.

### Resizing Picture Frames

If you resize a picture frame using the right mouse button, the picture is resized too. This only functions in both X and Y directions if Aspect lock has not been selected. This can be set in

**Menu**→**Picture**→**Modify picture** **F6**

If aspect lock has been set the picture will be resized according to the vertical size of the frame.



Fig. 8.26 - The info palette gives the size of the selected object. You can resize it by changing the **W** and **H** values and move it by changing the **X** and **Y** values.

### 8.8 Rotating Objects

You can rotate text frames, picture frames and lines. To rotate an object choose the Rotate tool on the toolbox (fig. 8.27) then left click and drag on any part of the object until it is at the desired angle (fig. 8.24). You may select a number of objects either before or after choosing the Rotate tool, and rotate them all by dragging on any object in the selection.

The centre of rotation for the object or selection is indicated by a small crosshair which is initially at the centre of the object or selection, but may be dragged to another position. Please note that if you choose the rotate tool when there is no selected object, the crosshair will not appear until you select one or more objects.

Note that the Picture frame info palette does not show the angle of rotation of the frame but the angle of rotation of the picture within the frame (fig. 10.9).

### Using the Info Palette

When the Rotate tool is chosen, the info palette provides a number of options concerned with rotating objects (fig. 8.28).

**A** is the angle of rotation of the selected object or group. The angle of rotation is in degrees and is applied anti-clockwise. You may type in a new value followed by Return to rotate the object to the desired angle. Alternatively click on the up and down icons to increase or decrease the angle.

If there is a selection of objects **A** refers to the first object selected. In this case, if **A** is changed, the first object is rotated as specified and the rest are rotated incrementally.

Clicking on the 3 x 3 grid will position the crosshair at the same relative position on the selected object or selection. The 9 points relate to the centre, the four corners and the centres of the four sides.

If **Crosshair** is selected, objects are rotated about the crosshair, otherwise they are rotated about their centres.

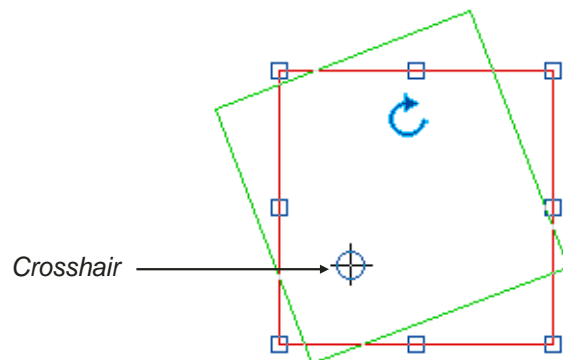
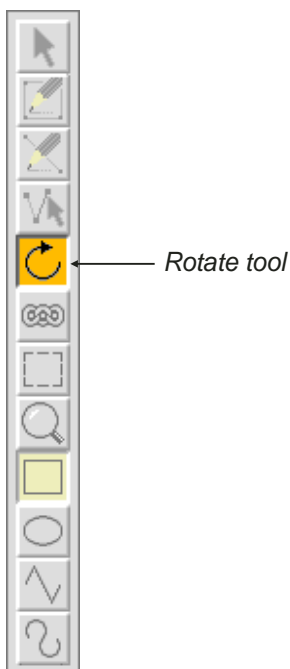

Fig. 8.24 - Use the Rotate tool to rotate the object around the crosshair.

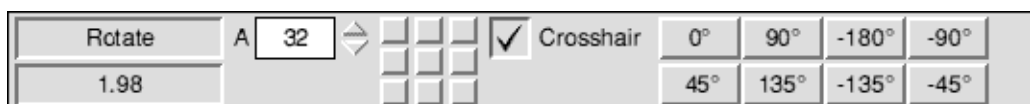

Fig. 8.27 - The toolbox.

Fig. 8.28 - When the Rotate tool is chosen, the info palette provides options to set the angle of rotation and alter the position of the centre of rotation.

## 8.9 Editing Objects using the Edit Menu

Menu→Edit→.....

This section describes the options on the Edit menu (fig. 8.29) concerned with objects. Some of these options use the clipboard (fig. 8.30) which can be viewed using the Clipboard option on the View menu (see 2.2).

The options **Clear**, **Cut**, **Copy** and **Delete** apply to selected objects provided that no text or picture is selected, otherwise they will apply to the text or picture.

### Clear

**Clear** deselects all selected objects.

### Select All Ctrl+A

**Select all** selects all objects on the current page. This is only possible if there is no active frame, otherwise it selects all the text in the active frame.

### Cut frame/line/selection Ctrl+X

**Cut** deletes selected objects, and places them on the clipboard, overwriting the previous contents.

### Copy frame/line/selection Ctrl+C

**Copy** copies the selected objects onto the clipboard, overwriting the previous contents.

### Paste frame/line/selection Ctrl+V

**Paste** inserts the object or objects that are on the clipboard, into the document. After choosing **Paste**, move the crosshair which then appears to the top left corner of where the object is to be pasted, and left click.

An object can be pasted into any *Ovation Pro* document, not just the one from which it was cut or copied. After pasting, the clipboard contents remain unchanged.

This option is only available if the clipboard contains an object or selection of objects.

### Delete frame/line/guideline/selection

This option deletes the selected object or objects.

### Undo / Redo Ctrl+Z / Ctrl+Y

**Undo** cancels the last operation performed, restoring your work to its previous state. **Redo** cancels the last undo operation performed.

The **Undo** and **Redo** options when applied to objects are identical to those described previously for text (see 3.4).

U <u>ndo</u> Caret left	Ctrl+Z
R <u>edo</u> Caret left	Ctrl+Y
C <u>u</u> t Group	Ctrl+X
C <u>o</u> py Group	Ctrl+C
P <u>a</u> ste clipboard	Ctrl+V
D <u>e</u> lete Group	Ctrl+K
E <u>mb</u> ed object	
S <u>e</u> lect all	Ctrl+A
C <u>l</u> ear	
F <u>i</u> nd...	Ctrl+F
F <u>i</u> nd next	F3

Fig. 8.29 - The **Edit** menu.

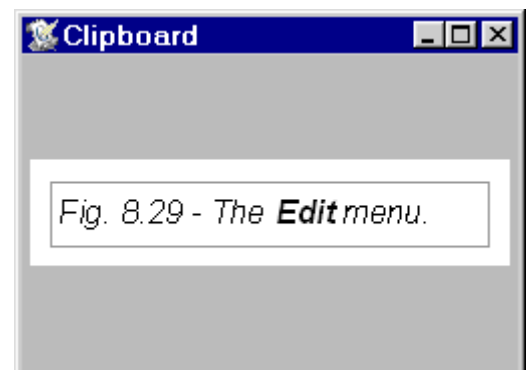

Fig. 8.30 - The clipboard containing a text frame.

## 8.10 Embedding Objects

### Menu → Edit → Embed object

Normally in *Ovation Pro* objects are anchored to the page, but **Edit → Embed object** allows you to embed an object or group into a text story such that the object moves with its associated text when the text reflows.

### How to Embed an Object

First draw the object anywhere on the page and Cut or Copy the object so that it is placed on the Clipboard. Now position the caret at the required insertion point in the text (*fig. 8.31*), and choose **Embed object**.

The embedded object is aligned with the text's baseline and behaves just like a large character which moves with its surrounding text when editing causes text reflow. The text after the caret is shifted to the right to make space for the object, and the line of text is shifted down to accommodate its height (*fig. 8.32*).

### Important Points

- **Embed object** is only available if the clipboard contains an object or group of objects. If the clipboard contains a selection of objects that are ungrouped, only the first object in the selection will be embedded.
- You cannot ungroup an embedded group.
- You can resize an embedded object as you would a normal object, but you cannot move it except by moving the text in which it is embedded.
- A text overflow will occur if you try to embed an object into a frame that is too small to contain it.
- After embedding, the clipboard contents remain unchanged.

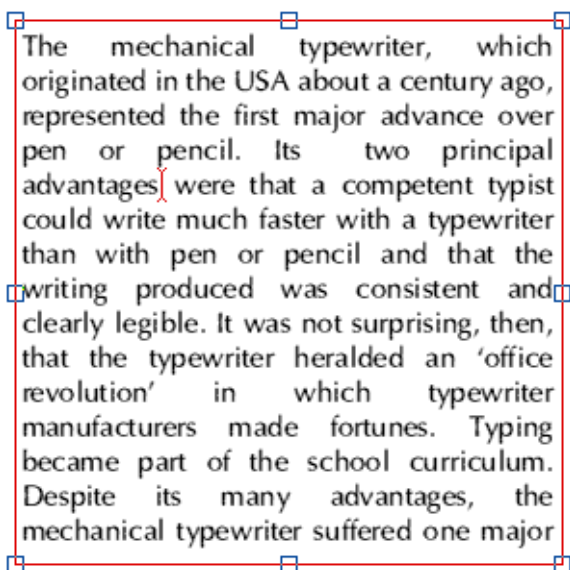

Fig. 8.31 - A text frame with the caret positioned ready for embedding an object.

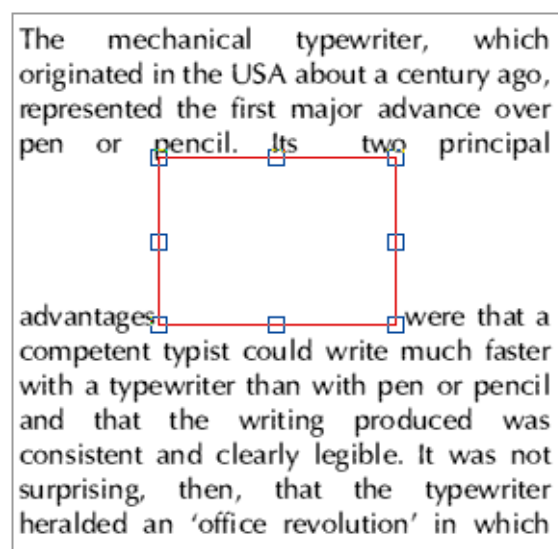

Fig. 8.32 - An embedded frame is aligned to the text baseline. The text is shifted to the right and the line moved down to make space for the object.

## Modifying an Embedded Object

### Menu⇨Object⇨.....

- If the embedded object is a frame, all the normal operations can be applied to the text or picture contents of the frame.
- From the **Object⇨Modify** dialogue box or **F7** (see 9.2) you can apply all options except for **X**, **Y** and **Lock**.
- From the **Object⇨Text flow** dialogue box you can only apply **Standoff**.
- **Border** and **Shape** can be applied, but all other options on the **Object** menu are not applicable.
- You can select an embedded object just like normal text and **Cut**, **Copy**, **Paste** and **Delete** it using options on the **Edit** menu.
- An embedded object can be placed in a paragraph on its own by ensuring there is a Return character directly before and after it (fig. 8.33).
- Options on the **Format** dialogue box such as **Indent**, **Alignment**, **Space before** and **Space after** can be applied to a paragraph that contains an embedded object. **Tabs** can also be applied.

- The bottom of an embedded object is aligned with the text's baseline, but you can shift it up and down vertically using **V.Shift** on the **Modify text** dialogue box. All other options on this dialogue box are not applicable.
- Relative leading (i.e. that specified as a percentage) is calculated from the size of the text in the line and not from the size of the embedded object.

## Embedding Pictures Directly

You can drag a picture directly from disc into a text story. A picture frame is then automatically embedded at the pointer position, and the picture placed in it.

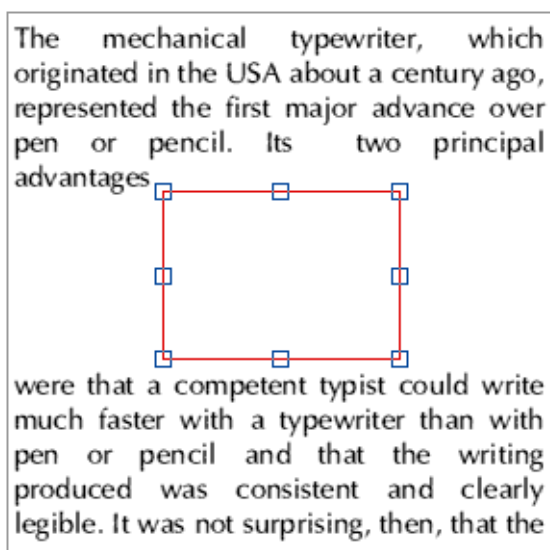

Fig. 8.33 - Embedded frame in a separate paragraph with **Centre** alignment.

## 8.11 Path Edit Mode

**Menu**→**Object**→**Shape**      **Ctrl+H**

The shape of objects drawn using straight and curved line segments, can be edited in Path Edit Mode.

You cannot edit the shape of rectangles or ellipses without changing them to polygons first using **Object**→**Shape** (see 9.9).

To edit a path, choose the Path Edit Mode tool on the toolbox (fig. 8.34) and left click on the path to be edited. This is not necessary if an object is selected before entering this mode.

The end points of each segment are shown in blue and may be dragged to reposition them (they will snap to the grid if grid lock is enabled). You can constrain movement to horizontal or vertical by holding down Shift while dragging. When moving a point you may use the cursor keys to nudge the pointer in any direction.

Left click over an end point to select the line segment. Left click whilst holding down Control on a point to add or remove a line segment to or from the selection. Selected end points and line segments are displayed in red. If you have a number of end points selected, moving one of them will move the entire selection.

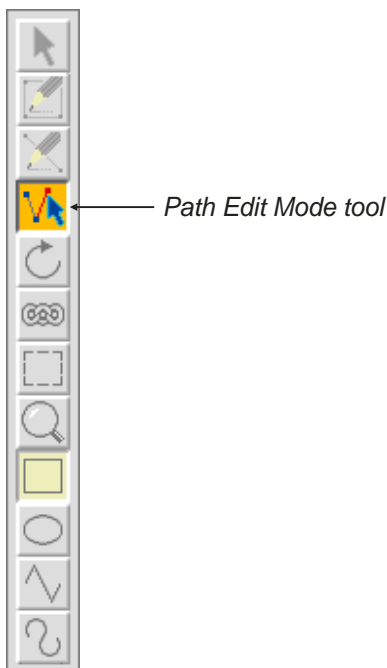

Fig. 8.34 - The toolbox.

If you select the end point of a curved segment, the control point for the Bezier curve is shown in orange and may be dragged to reposition it (fig. 8.35). If you hold down Shift while you drag a control point, the corresponding control point in the next curve is also moved to keep the angle of join constant.

To edit another path, left click over it. If the object you want to edit is obscured by another object, holding down Alt and double-clicking over the top object will select the one underneath. You can keep doing this to select progressively deeper objects.

If you find that editing paths is too slow because surrounding text is continually being redrawn, you can disable the redraws using an option on

**Menu**→**Misc**→**Choices**→**View**→....

Deselect 'Instant updates on path edit' (see 15.6).

When you have finished editing your object, leave Path edit mode by choosing the Select tool on the toolbox.

Please note that in Path Edit Mode most of the usual Ovation Pro operations are not available.

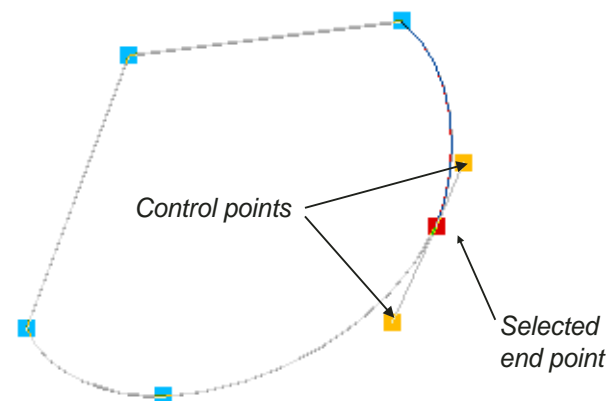

Fig. 8.35 - An irregular object in path edit mode with an endpoint selected. The two control points may be dragged to change the angle of join.



## Path Edit Options

In Path Edit Mode, the info palette provides a number of options concerned with editing the selected path (*fig. 8.36*). All of the options may be applied to a single selected segment or to a selection of segments.

The writable icons **X** and **Y** are the coordinates of the selected end point. Coordinates are measured from the ruler origin (normally the top left corner of the page). These values may be modified to change the position of the point. If there is a selection of points, **X** and **Y** refer to first end point selected. In this case, if **X** and **Y** are modified, the first end point is moved to the position specified and the rest are moved incrementally.

**Change to straight line** changes the selected curved line segment or move segment into a straight line.

**Change to curve** changes the selected straight line segment or move segment to a curved line.

**Change to move** changes the selected straight line segment or curved line segment to a move segment i.e. an invisible line.

**Make horizontal** moves the selected end point either up or down to make the line segment horizontal (relative to the object rotation).

**Make vertical** moves the selected end point either left or right to make the line segment vertical (relative to the object rotation).

**Add point** adds a new segment into the selected segment, of the same type as the selected segment.

**Delete segment** deletes the selected segment.

**Flatten path** straightens the join between two curved lines or a straight line and a curved line, so that the tangent is continuous at that point.

**Open/close path** turns a closed path into an open one, or an open path into a closed one.

**Snap to grid** aligns the selected end point to the grid. The grid or grid lock must be enabled for this option to work.

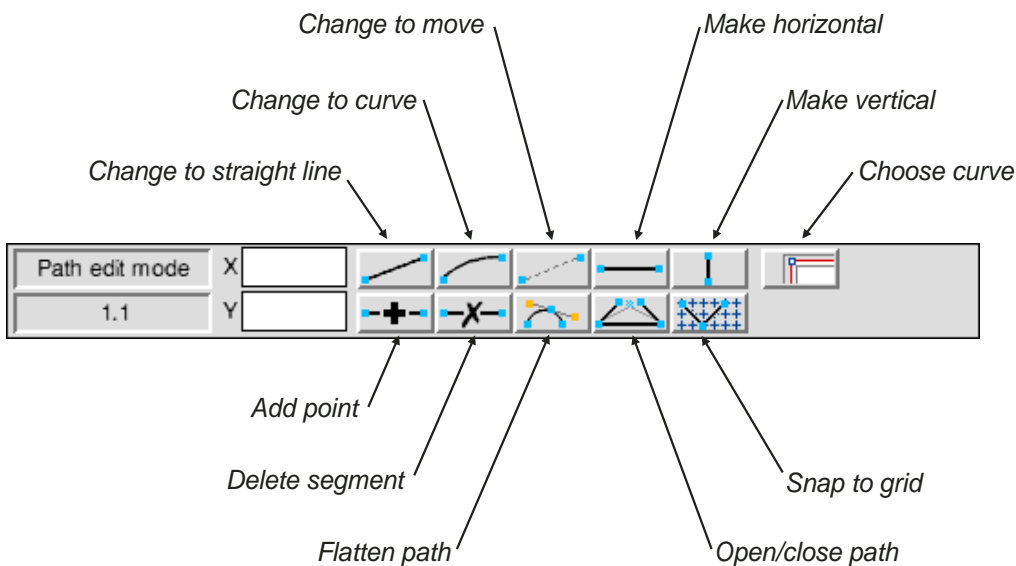
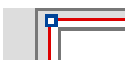
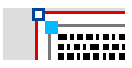
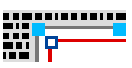

Fig. 8.36 - The info palette in **Path Edit Mode**

## Editing the Inset and Standoff Curves

The description above explains how to edit the shape of objects constructed using straight and curved line segments. However, you may also edit the 'curves' which repel text inside and outside a frame. This facility only applies to frames, and not lines which are always transparent and do not repel text. You cannot edit the Inset or Standoff curves for rectangles or ellipses without changing them to polygons first using the **Object→Shape** option (see 9.9). **Ctrl+H**

Clicking on **Choose curve** on the info palette (fig. 8.36) allows you to toggle through the following three modes:

-  Default mode: this allows you to edit the shape of the object.
-  Inset mode: this allows you to edit the Inset curve.
-  Standoff mode: this allows you to edit the Standoff curve.

Both Inset and Standoff curves are attached to the frame shape and are moved and resized when the frame is moved and resized.

## Editing the Inset Curve

To edit the Inset curve, click on the object you wish to edit and then toggle the **Choose curve** button on the info palette until you are in the Inset mode.

The Inset curve is positioned around the inside of the frame and repels the text flowing in the frame. By default it is the same shape as the frame, but positioned 1mm in from the edge of the frame (fig. 8.37). The default inset distance is specified on the **Modify** dialogue box (see 9.1). **F7**

The frame outline is drawn in grey with the Inset curve drawn in grey with the end points in blue. You can now edit the Inset curve using the same operations described on the previous pages (fig. 8.38).

If you wish to reset the Inset curve to its original shape and position, reset the Inset value on the **Modify** dialogue box to 1mm.

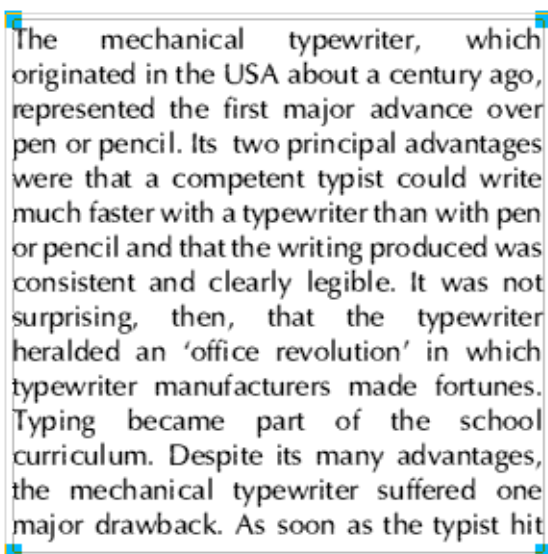

Fig. 8.37 - The outer line is the frame guideline and the inner line is the default Inset curve.

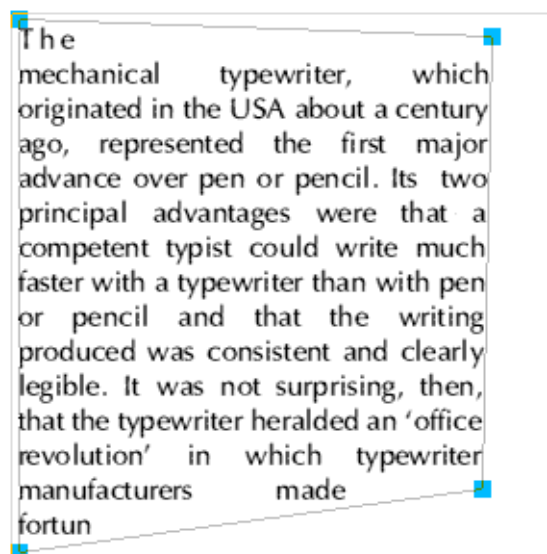

Fig. 8.38 - The Inset curve has been edited causing the text to flow inside the new shape.

## Editing the Standoff Curve

Menu⇨Object⇨Text flow **Ctrl+Shift+T**

To edit the Standoff curve, click on the object you wish to edit and then toggle the **Choose curve** button on the info palette until you are in the Standoff mode.

The Standoff curve is positioned around the outside of the frame and repels text flowing around the outside of the frame. By default it is the same shape as the frame, but positioned 1mm out from the edge of the frame (*fig. 8.39*). The default standoff distance is specified on the **Object⇨Text flow** dialogue box (*see 9.7*).

The frame outline is drawn in grey with the Standoff curve drawn in grey with the end points in blue. You can now edit the Standoff curve using the same operations described on the previous pages (*fig. 8.40*).

If you wish to reset the Standoff curve to its original shape and position, reset the **Standoff** value on the **Text flow** dialogue box to 1mm.

## Editing Picture Runaround

The **Picture** option on the **Object⇨Text flow** dialogue box automatically modifies the default Standoff curve so that it follows the shape of the picture instead of the frame. Using the facilities described in this chapter you may edit the Standoff curve to fine-tune the runaround shape to your exact requirements.

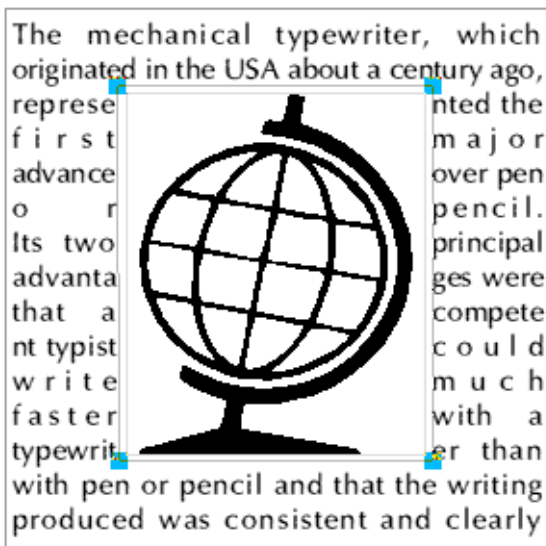

Fig. 8.39 - The inner line is the frame guideline and the outer line is the default Standoff curve.

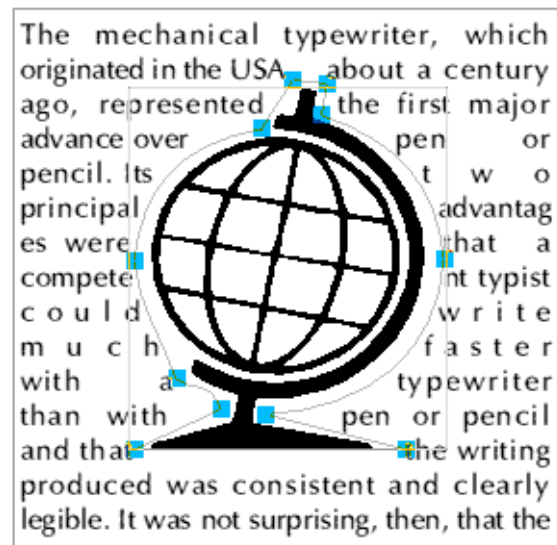

Fig. 8.40 - The Standoff curve has been edited causing the text to flow around the new shape.

Notes: